

N-Channel MOSFET

IRLML2402 (KRIML2402)

■ Features

- $V_{DS} (V) = 20V$
- $I_D = 1.2 A (V_{GS} = 4.5V)$
- $R_{DS(ON)} < 250m\Omega (V_{GS} = 4.5V)$
- $R_{DS(ON)} < 350m\Omega (V_{GS} = 2.7V)$

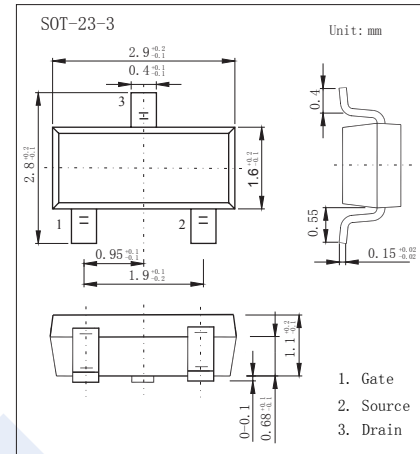
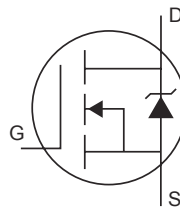

■ Absolute Maximum Ratings $T_a = 25^\circ C$

Parameter	Symbol	Rating	Unit	
Drain-Source Voltage	V_{DS}	20	V	
Gate-Source Voltage	V_{GS}	± 12		
Continuous Drain Current	I_D	$T_A=25^\circ C$	1.2	A
		$T_A=70^\circ C$	0.95	
Pulsed Drain Current	I_{DM}	7.4		
Power Dissipation	P_D	540	mW	
Linear Derating Factor		4.3	mW/ $^\circ C$	
Peak Diode Recovery dv/dt (Note.1)	dv/dt	5	V/ns	
Thermal Resistance Junction- to-Ambient	R_{thJA}	230	$^\circ C/W$	
Junction Temperature	T_J	150	$^\circ C$	
Storage Temperature Range	T_{stg}	-55 to 150		

Note.1: $I_{SD} \leq 0.93A$, $di/dt \leq 90A/\mu s$, $V_{DD} \leq V_{(BR)DSS}$, $T_J \leq 150^\circ C$

N-Channel MOSFET

IRLML2402 (KRIML2402)

■ Electrical Characteristics Ta = 25°C

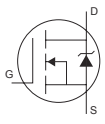
Parameter	Symbol	Test Conditions	Min	Typ	Max	Unit
Drain-Source Breakdown Voltage	V _{DSS}	I _D =250 μA, V _{GS} =0V	20			V
Zero Gate Voltage Drain Current	I _{BSS}	V _{DS} =16V, V _{GS} =0V			1	μA
		V _{DS} =16V, V _{GS} =0V, T _J =125°C			25	
Gate-Body Leakage Current	I _{GSS}	V _{DS} =0V, V _{GS} =±12V			±100	nA
Gate Threshold Voltage	V _{GS(th)}	V _{DS} =V _{GS} , I _D =250 μA	0.7		1.5	V
Static Drain-Source On-Resistance	R _{DS(on)}	V _{GS} =4.5V, I _D =0.93A (Note.1)			250	mΩ
		V _{GS} =2.7V, I _D =0.47A (Note.1)			350	
Forward Transconductance	g _{FS}	V _{DS} =10V, I _D =0.47A	1.3			S
Input Capacitance	C _{iss}	V _{GS} =0V, V _{DS} =15V, f=1MHz		110		pF
Output Capacitance	C _{oss}			51		
Reverse Transfer Capacitance	C _{rss}			25		
Total Gate Charge	Q _g	V _{GS} =16V, V _{DS} =4.5V, I _D =0.93A (Note.1)		2.6	3.9	nC
Gate Source Charge	Q _{gs}			0.41	0.62	
Gate Drain Charge	Q _{gd}			1.1	1.7	
Turn-On DelayTime	t _{d(on)}	V _{DS} =10V, I _D =0.93A, R _D =11Ω, R _G =6.2Ω (Note.1)		2.5		ns
Turn-On Rise Time	t _r			9.5		
Turn-Off DelayTime	t _{d(off)}			9.7		
Turn-Off Fall Time	t _f			4.8		
Body Diode Reverse Recovery Time	t _{rr}	I _F =0.93A, dI/dt=100A/μs, T _J =25°C (Note.1)		25	38	nC
Body Diode Reverse Recovery Charge	Q _{rr}			16	24	
Maximum Body-Diode Continuous Current	I _S	MOSFET symbol showing the integral reverse p-n junction diode. 			0.54	A
Pulse Source Current (Body Diode)	I _{SM}				7.4	
Diode Forward Voltage	V _{SD}	I _S =0.93A, V _{GS} =0V, T _J =25°C (Note.1)			1.2	V

Note.1: Pulse width ≤ 300μs; duty cycle ≤ 2%.

■ Marking

Marking	1A**
---------	------

N-Channel MOSFET IRLML2402 (KRIML2402)

■ Typical Characteristics

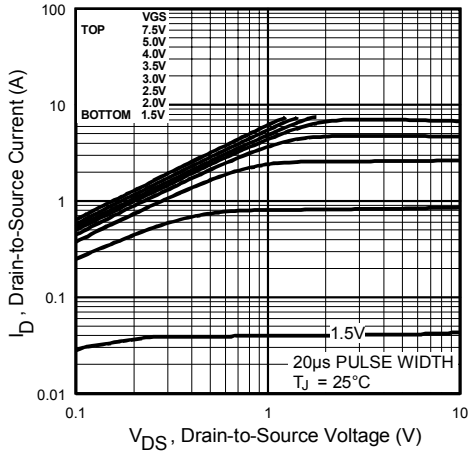

Fig 1. Typical Output Characteristics

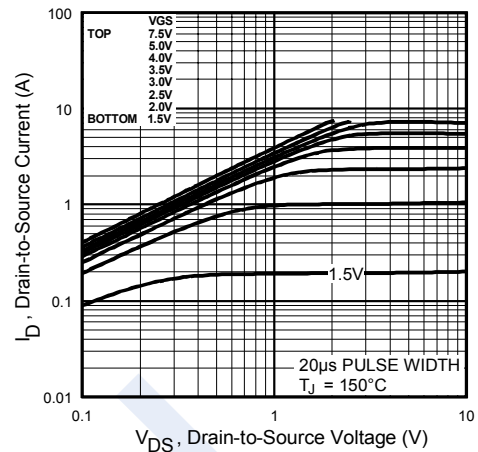

Fig 2. Typical Output Characteristics

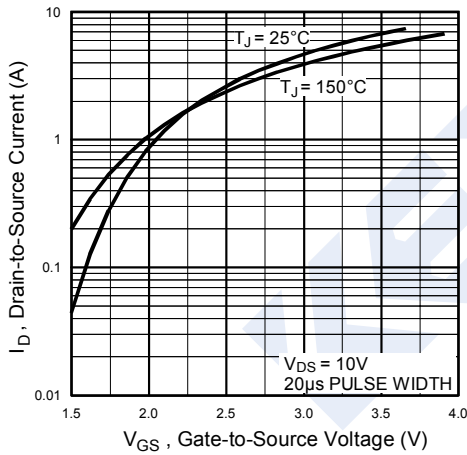

Fig 3. Typical Transfer Characteristics

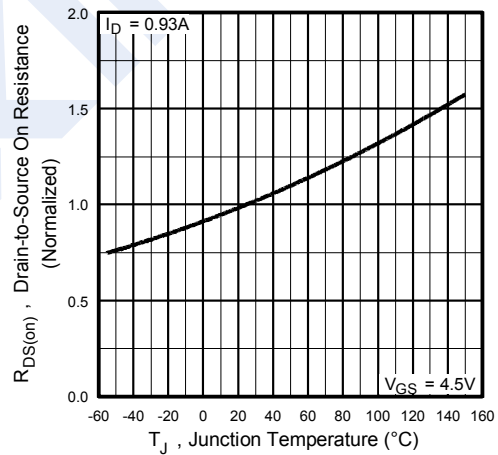

Fig 4. Normalized On-Resistance Vs. Temperature

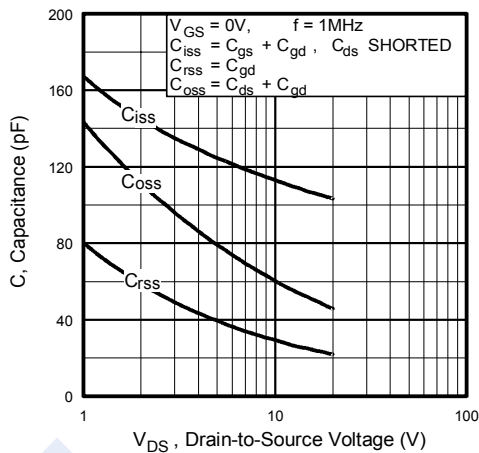

Fig 5. Typical Capacitance Vs. Drain-to-Source Voltage

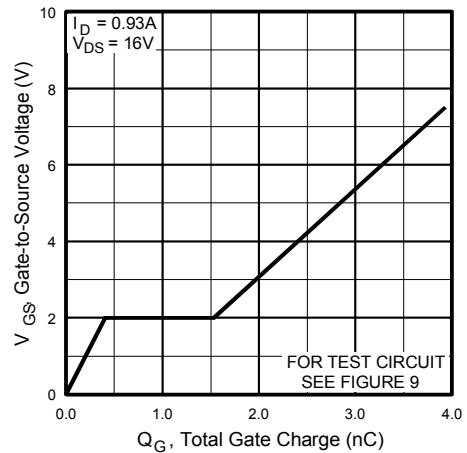

Fig 6. Typical Gate Charge Vs. Gate-to-Source Voltage

N-Channel MOSFET IRLML2402 (KRIML2402)

■ Typical Characteristics

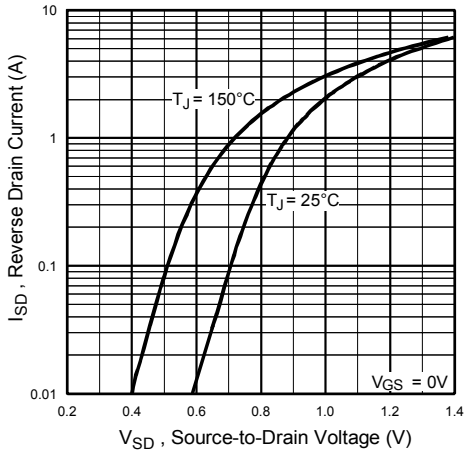

Fig 7. Typical Source-Drain Diode Forward Voltage

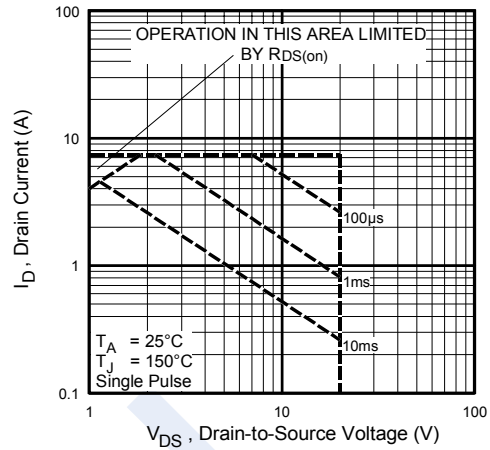

Fig 8. Maximum Safe Operating Area

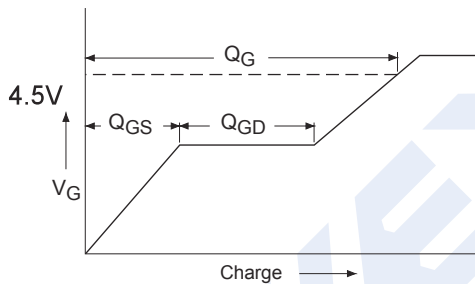

Fig 9a. Basic Gate Charge Waveform

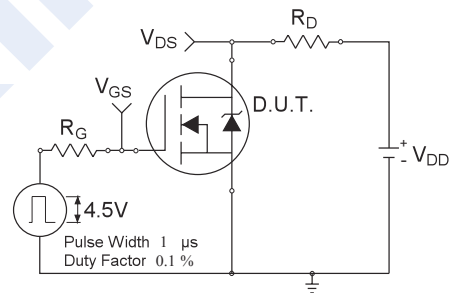

Fig 10a. Switching Time Test Circuit

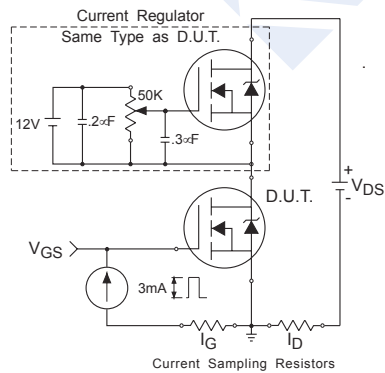

Fig 9b. Gate Charge Test Circuit

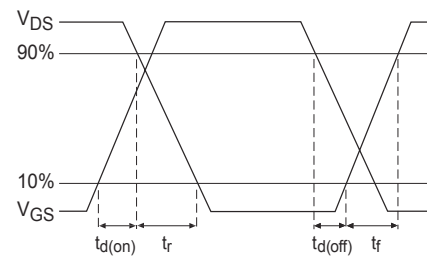

Fig 10b. Switching Time Waveforms

N-Channel MOSFET IRLML2402 (KRIML2402)

■ Typical Characteristics

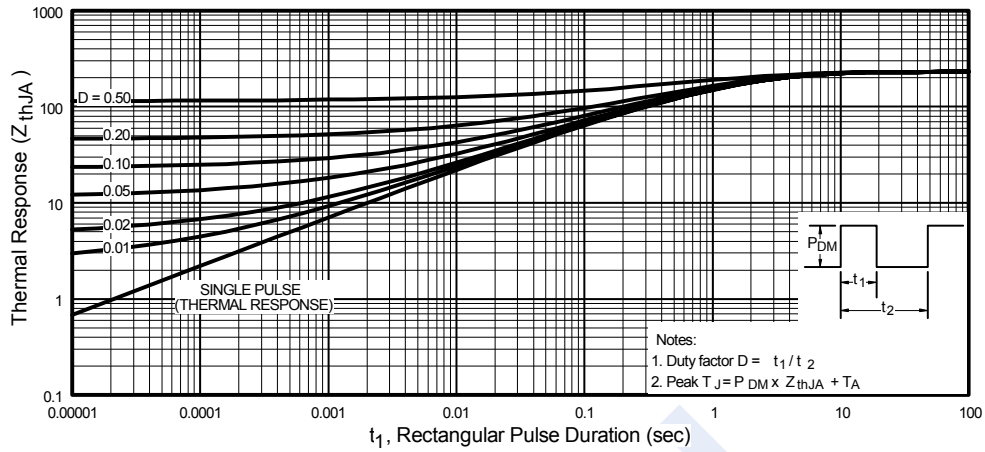

Fig 11. Maximum Effective Transient Thermal Impedance, Junction-to-Ambient

Peak Diode Recovery dv/dt Test Circuit

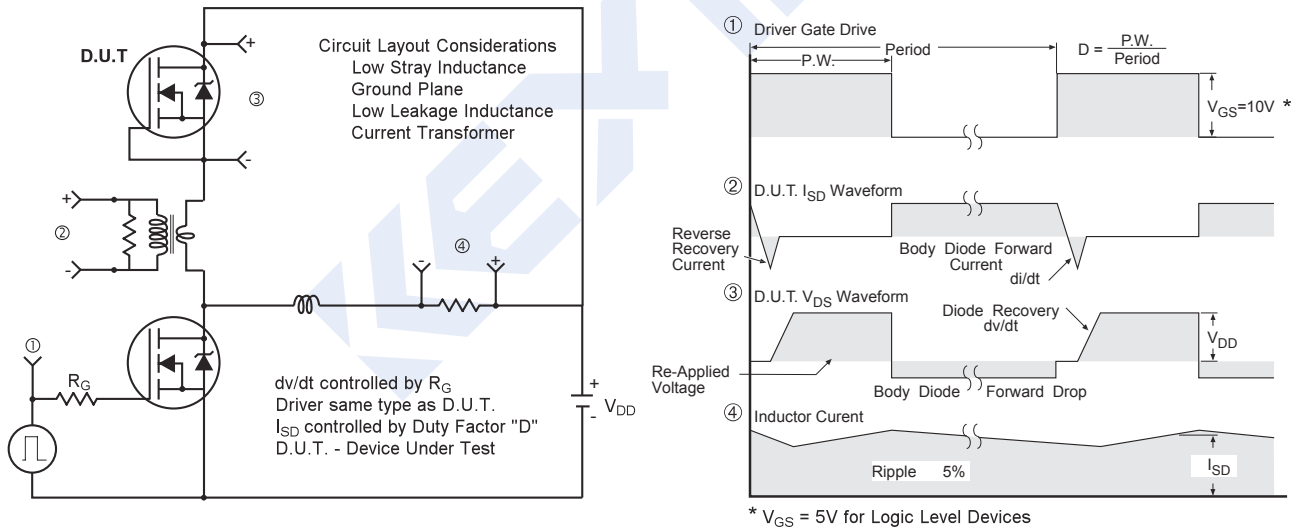

Fig 12. For N-Channel HEXFETS